

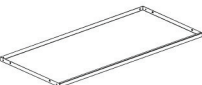











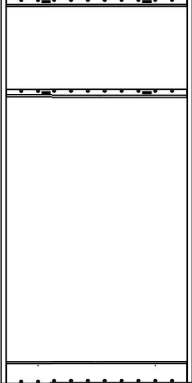
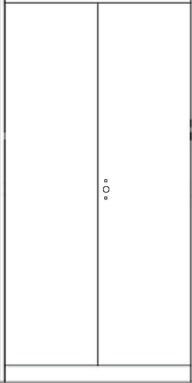

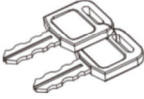
-  En cas de doute, contactez le fournisseur.
-  Veuillez lire attentivement les instructions avant de commencer l'assemblage.
-  Vérifiez tous les emballages pour vous assurer qu'ils ne sont pas endommagés et que tous les composants ont été fournis.
-  Le montage devrait être effectué par au moins deux personnes.
-  Attention lors de l'assemblage.
-  Portez des vêtements appropriés. Il est recommandé de porter des gants et des chaussures de sécurité.
-  Éliminez les matériaux d'emballage de manière responsable.
-  Veillez à ce que le plancher soit à niveau.
-  Prévoyez un espace de travail adéquat et soyez conscient des autres personnes qui travaillent autour de vous.
-  Ne conviens pas à une utilisation dans des environnements humides ou mouillés.
-  Soyez prudent lorsque vous manipulez des objets lourds, en particulier lorsque vous les soulevez ou que vous vous étirez.

## Liste des pièces

<p>Plaque supérieure: 1 mcx</p>  <p><b>A</b></p>	<p><b>D</b></p>  <p>Vis autotaraudeuse (4*12): 6 mcx</p>	<p><b>I</b></p>  <p>Serrure à clé: 2 jeux</p>	<p><b>M</b></p> 	<p><b>N</b></p> 	<p><b>O</b></p>  <p>Plaque dorsale: 1 mcx</p>	<p><b>P</b></p>  <p>Porte: 1 pc</p>
<p>Plaque inférieure: 1 mcx</p>  <p><b>B</b></p>	<p><b>E</b></p>  <p>Clés: 1 jeu</p>	<p><b>J</b></p>  <p>Capuchon en plastique: 2 mcx</p>				
<p>Tablette: 1 mcx</p>  <p><b>C</b></p>	<p><b>F</b></p>  <p>Support pour barre de suspension: 2 mcx</p>	<p><b>G</b></p>  <p>M6* 12: 2mcx</p>	<p><b>K</b></p>  <p>Couvercle pour serrure: 1 mcx</p>			
	<p><b>H</b></p>  <p>Barre de suspension: 1 mcx</p>	<p><b>L</b></p>  <p>Barre de verrouillage: 2 mcx</p>	<p>Plaque latérale gauche: 1 mcx Plaque latérale droite: 1 mcx</p>			

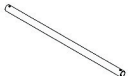
(1) Boulonnez la plaque latérale gauche à la plaque de fond avec 3 vis autotaraudeuse (4\*12).

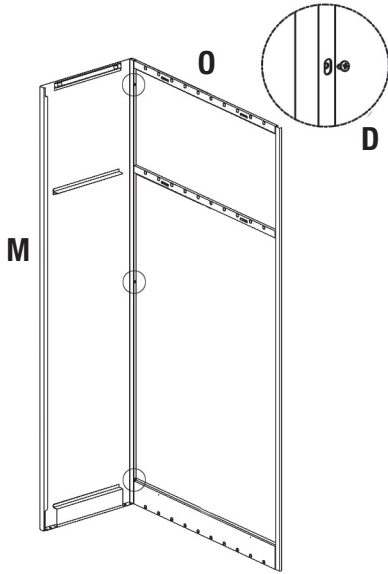

(2) Boulonnez la plaque latérale droite à la plaque de fond avec 3 vis autotaraudeuse (4\*12).

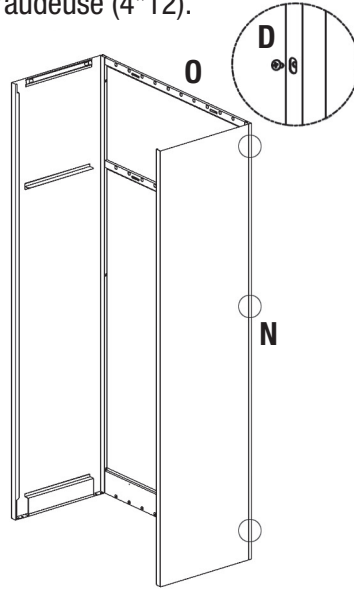

(3) Ouvrez la porte et fixez le cadre de la porte aux plaques latérales.

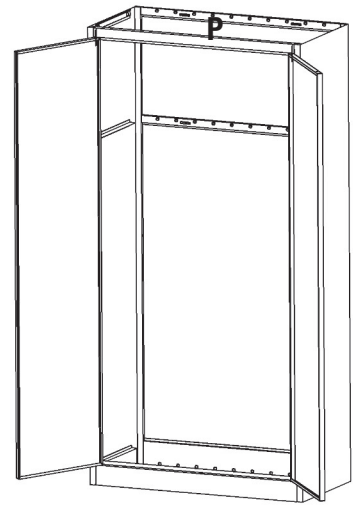

(4) Repérez la plaque supérieure et inférieure.

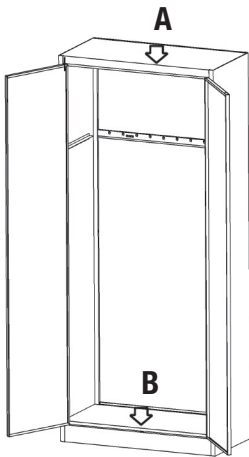

(5) Repérez la tablette.

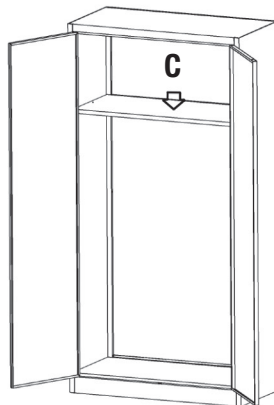

(6) Fixez le support de la barre de suspension avec les vis M6\* 12 et installez la barre.

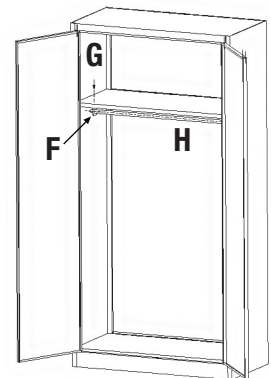

(7) Placez le capuchon en plastique sur les barres de verrouillage supérieure et inférieure, et fixez la serrure et son couvercle selon le schéma.

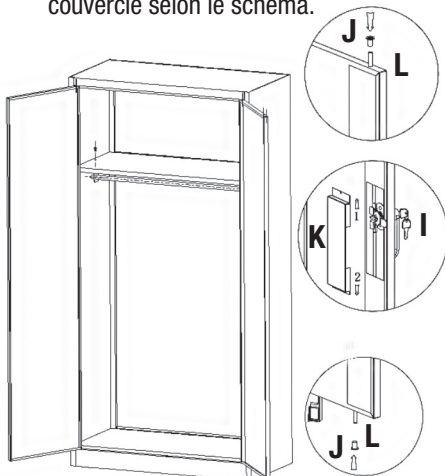

(8) Complet.

